

- Geïsoleerde ventilatiekast
- Enkelwandig
- IP44



Ventilatiekasten 40 mm geluidsisolatie type BFA

Centrifugale ventilatiekast met geluidsisolatie (40 mm/88 kg/m³)

Toepassing

- **BFA** ventilatoren worden gebruikt voor ventilatie waar een laag geluidsniveau vereist is, zoals kantoren, horecazaken, hotels enz.

Specificatie RE1, RE2, RE#-type

- Waaier met achterwaarts gebogen schoepen.
- Enkel / dubbel aanzuigende waaier afhankelijk van de grootte.
- Waaier van gegalvaniseerd plaatstaal, behalve 125-RE1 en 160-RE1 met stalen plaat en plastic schoepen.
- Buitenpool motor 230Vac 1ph, IP44.

Accessoires

- 5-standen schakelaar type **BTRN** of **BTRNTK**
- Flexibele aansluiting type **BMK**
- Filterkast type **FLK BN** (G4 filter) of **FLF B** (F7 filter)
- Geluidsdemper type **SARG**
- Kanaal batterij type **CVA**, **CWA** en **CWK**

Bestelvoorbeeld

BFA 160 RE1 + BTRN-1-S1

BFA 160 RE1 = ventilator

BTRN-1-S1 = snelheidsregelaar

Grafieken

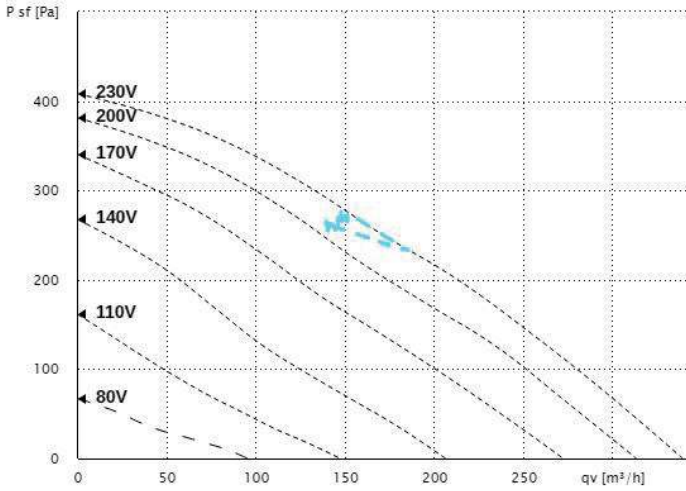

BFA 125 E2 K 01

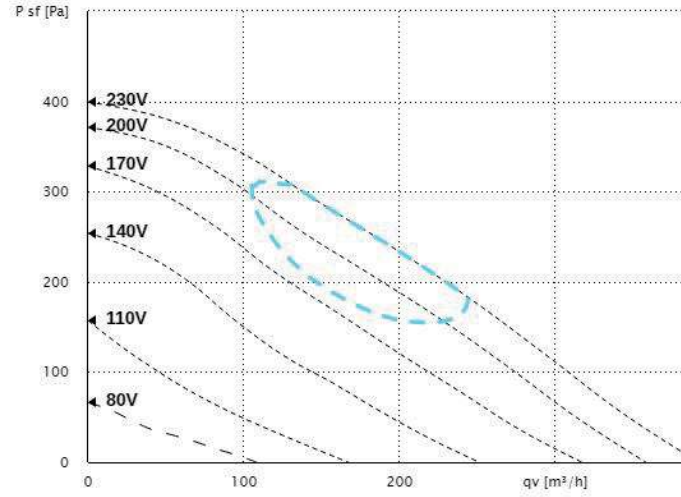

BFA 150 E2 K 01

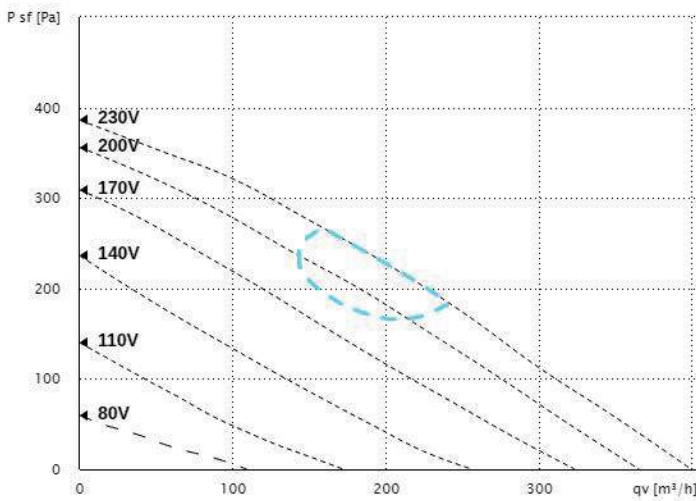

BFA 160 E2 K 01

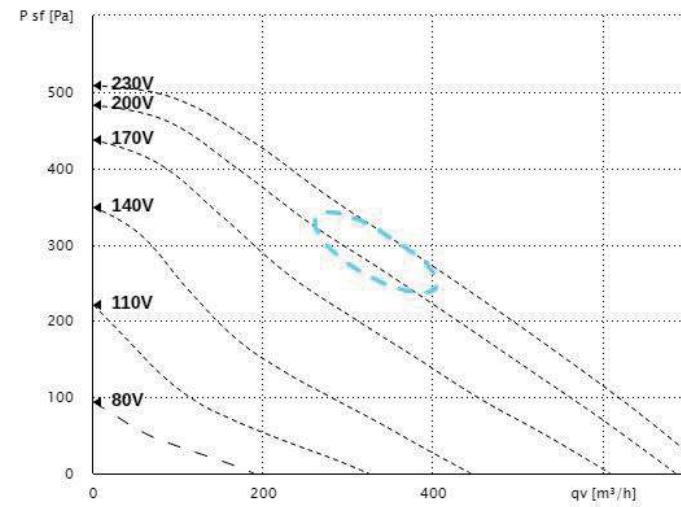

BFA 200 E2 K 01

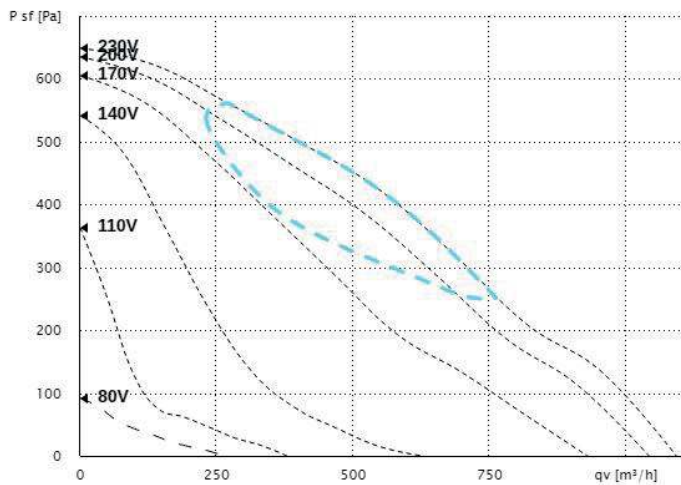

BFA 250 E2 K 01

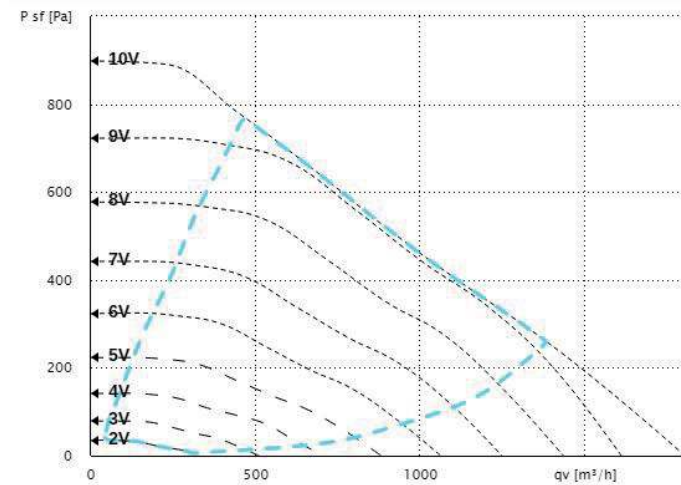

BFA 315 E2 K 01

Grafieken 2

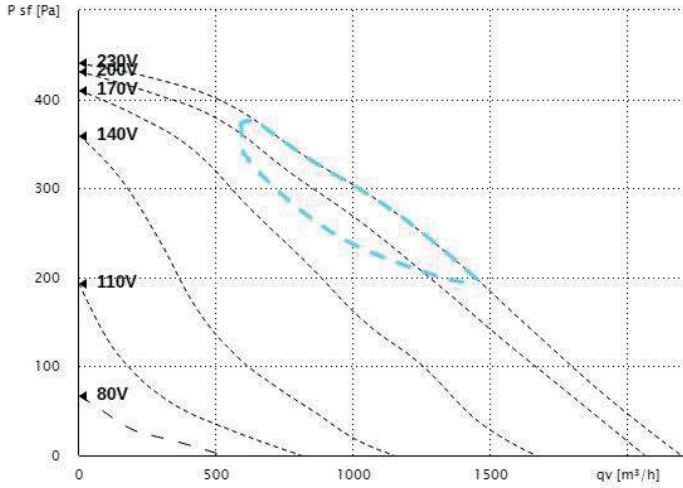

BFA 355 E4 K 01

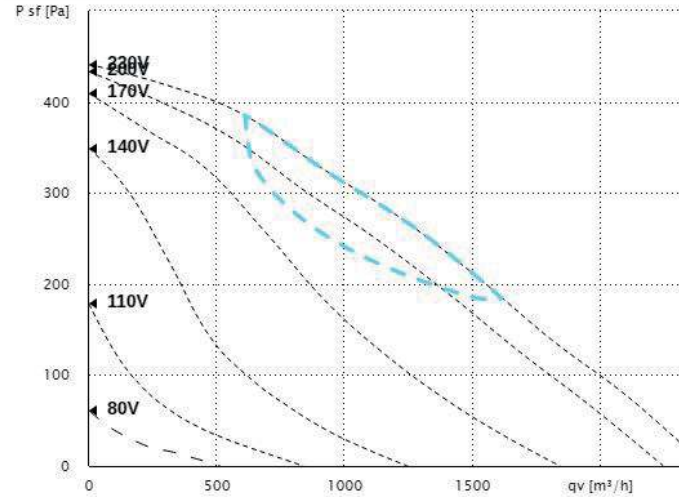

BFA 400 E4 K 01

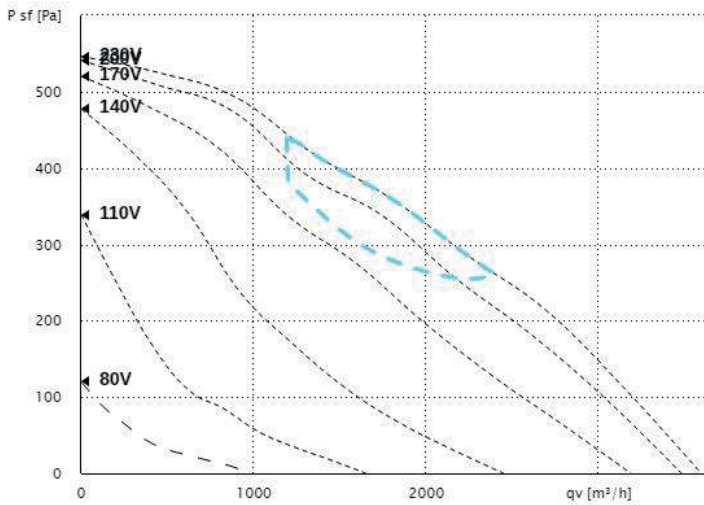

BFA 450 E4 K 01

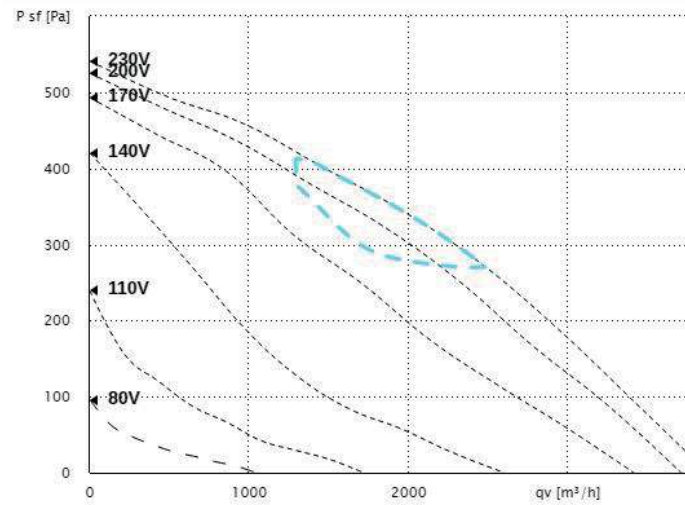

BFA 500 E4 K 01

	Luchttechnische gegevens								
	Q [m³/h]								
	50 Pa	100 Pa	150 Pa	200 Pa	250 Pa	300 Pa	400 Pa	500 Pa	
BFA 125 E2 20	307	283	243	211	170	130	-	-	
BFA 160 E2 20	356	310	269	226	173	123	-	-	
BFA 200 E2 11	675	614	550	485	422	361	229	-	
BFA 355 E4 20	1982	1786	1640	1422	1253	1017	491	-	
BFA 400 E4 20	2208	1977	1750	1532	1323	1046	462	-	
BFA 450 E4 20	3403	3197	2978	2709	2413	2164	1443	800	
BFA 500 E4 20	3639	3375	3126	2830	2552	2275	1497	481	

	Technische gegevens												
	U [V]	P [W]	I [A]	SCr	SCe**	ηt [%]	tm [°C]	tu [°C]	to [°C]	n [rpm]	Lwa [dB (A)]		
											Lwa 5	Lwa 6	Lwa 2
BFA 125 E2 20	230	50	0.3	BTRN-1-S1	MTY 1,5	24.6	70	70	-25	2386	55	68	54
BFA 160 E2 20	230	49	0.3	BTRN-1-S1	MTY 1,5	25.5	70	70	-25	2420	57	71	54
BFA 200 E2 11	230	100	0.5	BTRN-1-S1	MTY 1,5	29.1	80	80	-25	2480	64	76	59
BFA 355 E4 20	230	237	1.3	BTRN-1-1	MTY 2,5	38.5	45	45	-25	1368	66	75	61
BFA 400 E4 20	230	242	1.3	BTRN-1-1	MTY 2,5	39.5	40	40	-25	1370	67	76	62
BFA 450 E4 20	230	451	2.6	BTRN-1-3	MTY 4	41.3	65	65	-25	1374	73	82	67
BFA 500 E4 20	230	466	2.7	BTRN-1-3	MTY 4	41.2	65	65	-25	1382	73	82	67

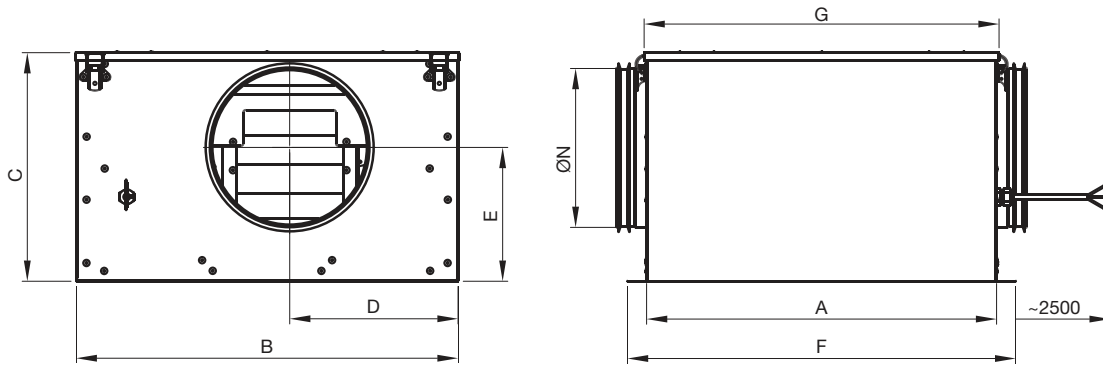

	Afmetingen								
	Ø N [mm]	A [mm]	B [mm]	C [mm]	D [mm]	E [mm]	F [mm]	G [mm]	[kg]
BFA 125 E2 20	124	378	380	232	119	136	426	384	11.3
BFA 160 E2 20	159	378	380	232	137	133	426	384	11.8
BFA 200 E2 11	199	460	480	287	165	168	508	466	17.7
BFA 355 E4 20	354	650	680	492	234	273	698	656	41.8
BFA 400 E4 20	399	650	680	492	256	263	698	656	41.0
BFA 450 E4 20	449	800	780	547	276	283	847	805	67.5
BFA 500 E4 20	499	800	780	587	302	293	847	805	69.5